



PROGRAMMING AND OPTIMIZATION FOR INTEL[®] ARCHITECTURE

The Hands-On Workshop (HOW) Series
Session 9

Colfax International — colfaxresearch.com

September 2016

While best efforts have been used in preparing this training, Colfax International makes no representations or warranties of any kind and assumes no liabilities of any kind with respect to the accuracy or completeness of the contents and specifically disclaims any implied warranties of merchantability or fitness of use for a particular purpose. The publisher shall not be held liable or responsible to any person or entity with respect to any loss or incidental or consequential damages caused, or alleged to have been caused, directly or indirectly, by the information or programs contained herein. No warranty may be created or extended by sales representatives or written sales materials.

- ▶ HOW to Program Intel Architecture
 - 01. Parallelism, specialization, guided tour – Sep 26
 - 02. Programming Intel Xeon Phi (KNC, KNL) – Sep 27
- ▶ HOW to Express Parallelism
 - 03. Automatic vectorization – Sep 28
 - 04. Multi-threading with OpenMP – Sep 29
- ▶ HOW to Get Performance
 - 05. Comprehensive demo – Sep 30
 - 06. Scalar & vectorization tuning – Oct 3
 - 07. Multi-threading: common issues – Oct 4
 - 08. Multi-threading: memory aspect – Oct 5
 - 09. Memory traffic – Oct 6
- ▶ HOW to Scale
 - 10. Distributed Computing: MPI – Oct 7

September 2016						
S	M	T	W	H	F	S
				1	2	3
4	5	6	7	8	9	10
11	12	13	14	15	16	17
18	19	20	21	22	23	24
25	26	27	28	29	30	

October 2016						
S	M	T	W	H	F	S
						1
2	3	4	5	6	7	8
9	10	11	12	13	14	15
16	17	18	19	20	21	22
23	24	25	26	27	28	29
30	31					

■ — Webinar+remote access

Course page: colfaxresearch.com/how-16-09

- ▶ Slides (including this one), code downloads
- ▶ Video of recorded sessions
- ▶ Chat (during webinars or offline)



Additional resources:

- ▶ More workshops like this one: colfaxresearch.com/training
- ▶ Video courses: colfaxresearch.com/video-courses

GET YOUR QUESTIONS ANSWERED

Chat (current):

colfaxresearch.com/how-16-09



Forums (technical):

colfaxresearch.com/discussion

COLFAX RESEARCH

CONTRIBUTING TO INNOVATIONS IN COMPUTING

[Log In/Register](#)

[/](#) [READ](#) [WATCH](#) [LEARN](#) [FORUMS](#) [CONNECT](#) [JOIN](#)

Join the Conversation

Welcome to Colfax Research forums, an online community for you to engage with HPC experts, software architects, developers, computational researchers, scientists, students and more—so you can acquire new knowledge, share ideas, and build new relationships.

Tap our experts and your peers to help meet the challenge of optimizing applications on modern hardware. This is the place to browse or post questions (and get answers) related to computational science, parallel programming and code modernization on Intel® Architecture.

Welcome aboard. Post questions today!

Email (organizational):

training@colfax-intl.com

HANDS-ON EXERCISES AND REMOTE ACCESS

- ▶ 96 people receive a remote access token
- ▶ Virtualized Intel Xeon CPU, real Intel Xeon Phi coprocessor (1st gen, KNC), SW tools
- ▶ Can access the system the entire 2 weeks of the workshop

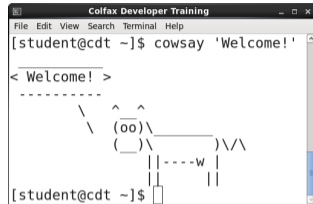

```
Colfax Developer Training
File Edit View Search Terminal Help
[student@cdt ~]$ cowsay 'Welcome!'
< Welcome! >
-----
      \   ^__^
         (oo)\_____)
            (_____)
                )\/)
                 ||----w |
                 ||     ||

[student@cdt ~]$
```

- ▶ Not among the 96? Stay tuned: follow along with instructor, use own system, or wait for a seat
- ▶ Use it or lose it: if you do not log in for a while, remote access token goes to next student on the list



§2. REFRESH



PERFORMANCE OPTIMIZATION

Intel Xeon Processor



Current: Broadwell
Upcoming: Skylake

Multi-Core Architecture

Intel Xeon Phi Coprocessor, 1st generation

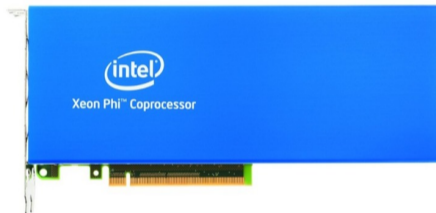

Knights Corner (KNC)

Intel Xeon Phi Processor, 2nd generation*



* socket and coprocessor versions

Knights Landing (KNL)

Intel Many Integrated Core (MIC) Architecture

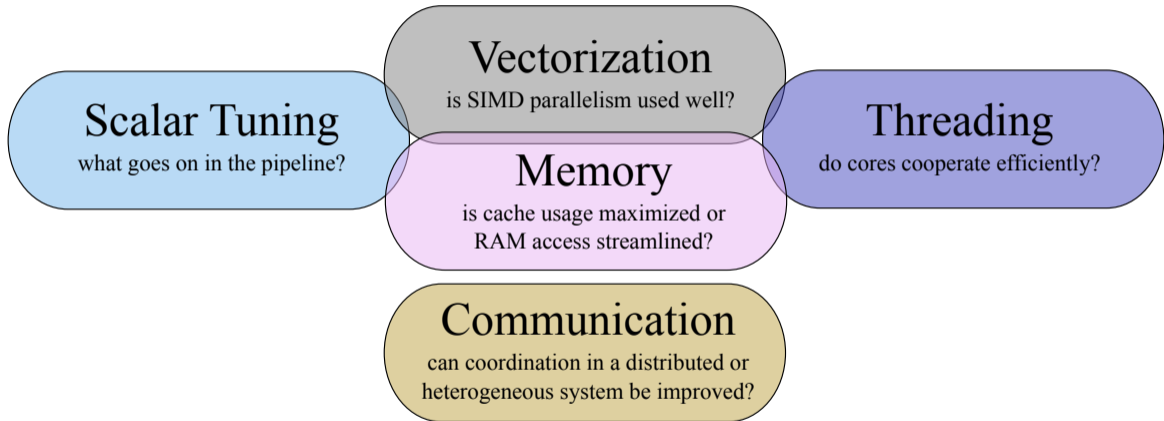



§3. MEMORY TRAFFIC TUNING



MEMORY HIERARCHY

INTEL XEON CPU: MEMORY ORGANIZATION

- ▶ Hierarchical cache structure
- ▶ Two-way processors have NUMA architecture

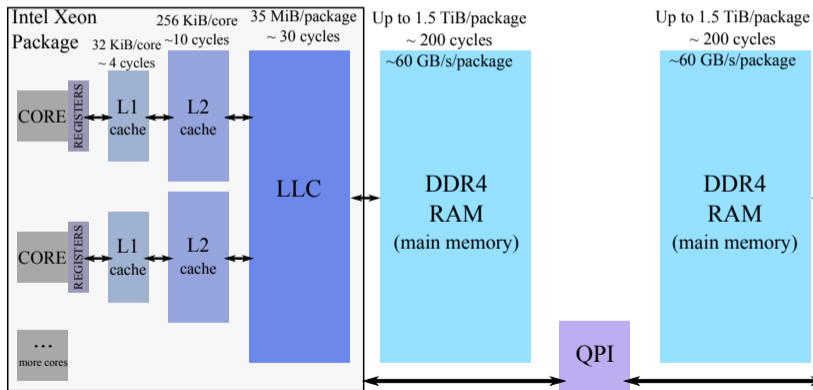

KNC MEMORY ORGANIZATION

- ▶ Direct access to ≤ 16 GiB of cached GDDR5 memory on board
- ▶ No access to system DDR4, connected to host via PCIe

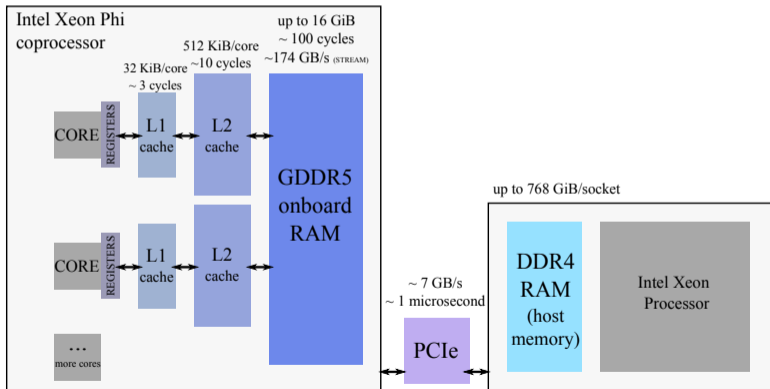
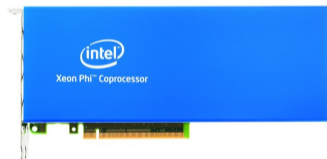

KNL MEMORY ORGANIZATION

- ▶ Direct access to on-package MCDRAM *and* system DDR4 (socket)
- ▶ Use MCDRAM as cache, in flat mode, or as hybrid

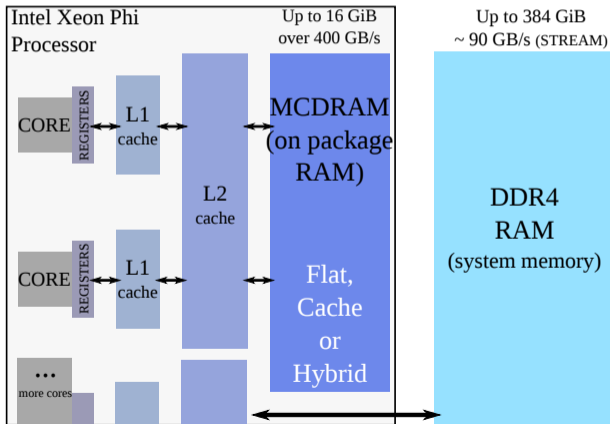
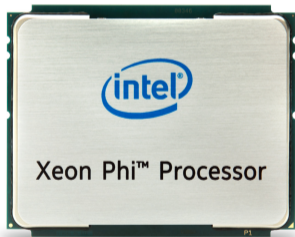

- ▶ Minimal block of data transferred between memory and cache
- ▶ 64 bytes long in Intel Architecture
- ▶ Aligned on 64-byte boundaries in memory

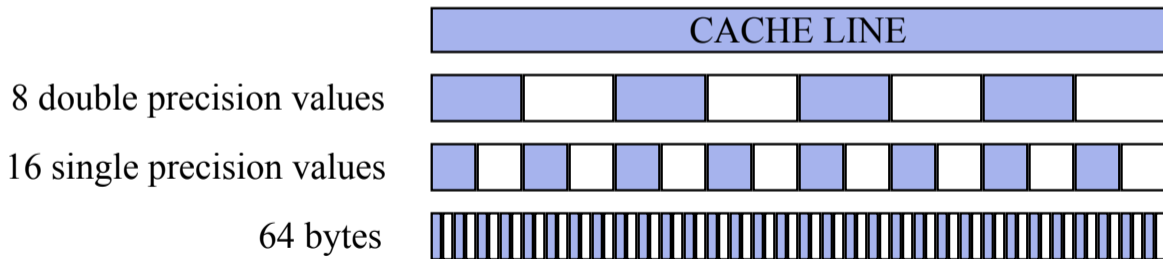



MEMORY RE-USE AND ALGORITHMS

LOOP WAS VECTORIZED, NOW WHAT?

1. Ensure unit stride access
2. Align data
3. Pad multi-dimensional containers
4. Eliminate peel loops
5. Eliminate multiversioning
6. **Optimize data re-use in caches**

Good to Know

Vector FLOPs are cheap compared to memory access.

If your data is served by RAM and not caches, it does not matter if you have vectorization: you will be bottlenecked by memory access.

HOW CHEAP ARE FLOPS?

Theoretical estimates, Intel Xeon E5-2697 V3 processor

Performance = 28 cores \times 2.7 GHz \times (256/64) vec.lanes \times 2 FMA \times 2 FPU \approx 1.2 TFLOP/s

Required Data Rate = 1.2 TFLOP/s \times 8 bytes \approx 10 TB/s

Memory Bandwidth = $\eta \times 2 \times 59.7 \approx$ 0.1 TB/s

Ratio = 10/0.1 \approx 100 (FLOPs)/(Memory Access)

If the Arithmetic Intensity is...

- ▶ > 100 (FLOPs)/(Memory Access) — Compute Bound Application
- ▶ < 100 (FLOPs)/(Memory Access) — Bandwidth Bound Application

ON COMPUTATIONAL COMPLEXITY OF ALGORITHMS

Type	Properties	Examples
$O(N)$	Each data element is used a fixed number of times. Memory-bound unless the number of times is large.	Array scaling, image brightness adjustment, vector dot-product.
$O(N^\alpha)$	Each element is used $N^{\alpha-1}$ times. A lot of data reuse for $\alpha > 1$. Good implementation can be compute-bound, poor one – memory-bound.	Matrix-matrix multiplication: $O(N^{3/2})$ (N = amount of data in matrix), direct N-body calculation: $O(N^2)$
$O(N \log N)$	Each element is used $\log N$ times. For small problems – memory-bound, for very large problems transitions to compute-bound	Fast Fourier transform, merge sort
$O(\log N)$	Always memory-bound.	Binary search

N = data size

ARITHMETIC INTENSITY AND ROOFLINE MODEL

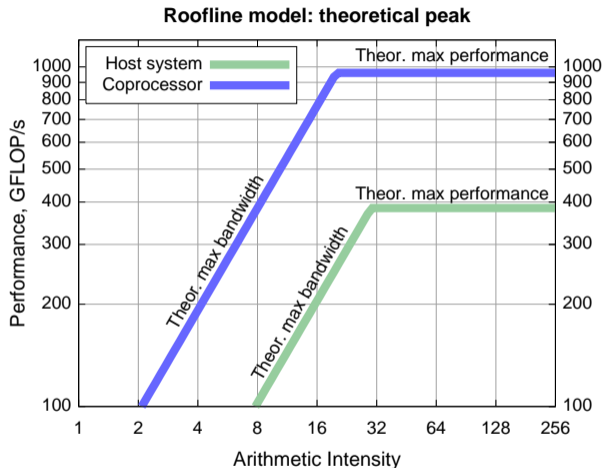

More on roofline model: [Williams et al.](#)

LOOP PERMUTATION

PRINCIPLE

Choose loop order to maintain unit-stride memory access

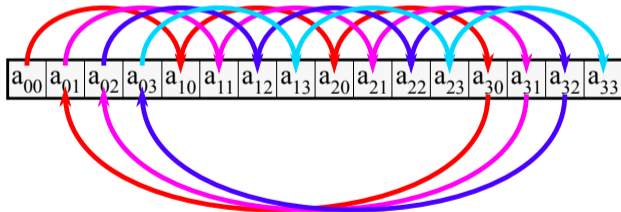
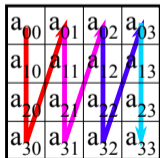
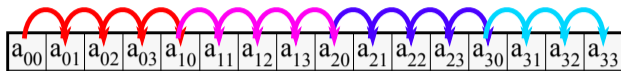
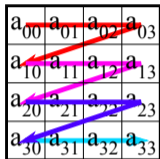

Compiler may or may not be able to automate loop permutation.

EXAMPLE: OVER-SIMPLIFIED MATRIX-MATRIX MULTIPLICATION

$$C = AB \quad \Leftrightarrow \quad C_{ij} = \sum_{k=0}^{n-1} A_{ik}B_{kj}$$

Before:

```

1  #pragma omp parallel for
2  for (int i = 0; i < n; i++)
3      for (int j = 0; j < n; j++)
4      #pragma vector aligned
5          for (int k = 0; k < n; k++)
6              C[i*n+j] += A[i*n+k] * B[k*n+j];

```

After:

```

1  #pragma omp parallel for
2  for (int i = 0; i < n; i++)
3      for (int k = 0; k < n; k++)
4      #pragma vector aligned
5          for (int j = 0; j < n; j++)
6              C[i*n+j] += A[i*n+k] * B[k*n+j];

```

PRINCIPLE

- ▶ The order of nested loops must be chosen for best locality of data access
- ▶ At -O2 and above, the compiler automatically interchanges loops in some cases
- ▶ In other cases, loop interchange must be investigated manually

LOOP FUSION

LOOP FUSION TECHNIQUE

Re-use data in cache by fusing loops in a data processing pipeline

```
1 MyDataType* data = new MyDataType(n);  
2  
3 for (int i = 0; i < n; i++)  
4     Initialize(data[i]);  
5  
6 for (int i = 0; i < n; i++)  
7     Stage1(data[i]);  
8  
9 for (int i = 0; i < n; i++)  
10    Stage2(data[i]);
```

```
1 MyDataType* data = new MyDataType(n);  
2  
3 for (int i = 0; i < n; i++) {  
4  
5     Initialize(data[i]);  
6  
7     Stage1(data[i]);  
8  
9     Stage2(data[i]);  
10 }
```

Potential positive side-effect: less data to carry between stages, reduced memory footprint, improved performance (see, e.g., [this paper](#)).

EXAMPLE APPLICATION -- PERFORMANCE

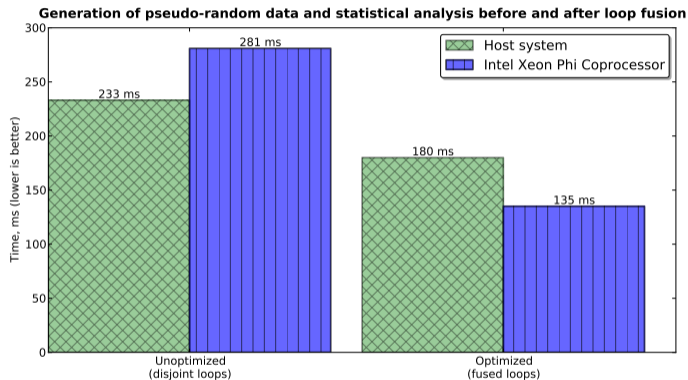

See [labs/4/4.09-memory-loop-fusion-statistics/](#)

LOOP TILING

LOOP TILING

Original:

```
for (i=0; i<m; i++)
  for (j=0; j<n; j++)
    ...=...*b[j];
```

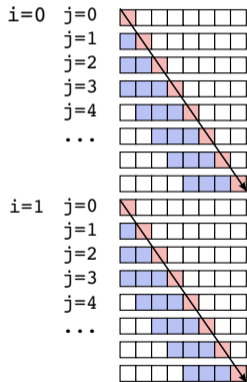

- - cached, LRU eviction policy
- - cache miss (read from memory, slow)
- - cache hit (read from cache, fast)

Cache size: 4

TILE=4

(must be tuned to cache size)

Cache hit rate without tiling: 0%

Cache hit rate with tiling: 50%

Tiled:

```
for (jj=0; jj<n; jj+=TILE)
  for (i=0; i<m; i++)
    for (j=jj; j<jj+TILE; j++)
      ...=...*b[j];
```

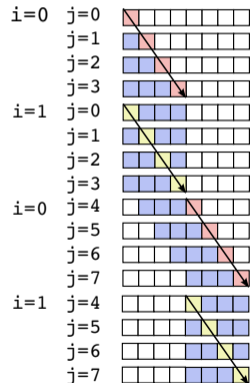

LOOP TILING (CACHE BLOCKING) -- PROCEDURE

```
1  for (int i = 0; i < m; i++) // Original code:  
2      for (int j = 0; j < n; j++)  
3          compute(a[i], b[j]); // Memory access is unit-stride in j
```

```
1  // Step 1: strip-mine inner loop  
2  for (int i = 0; i < m; i++)  
3      for (int jj = 0; jj < n; jj += TILE)  
4          for (int j = jj; j < jj + TILE; j++)  
5              compute(a[i], b[j]); // Same order of operation as original
```

```
1  // Step 2: permute  
2  for (int jj = 0; jj < n; jj += TILE)  
3      for (int i = 0; i < m; i++)  
4          for (int j = jj; j < jj + TILE; j++)  
5              compute(a[i], b[j]); // Re-use to j=jj sooner
```

LOOP TILING (UNROLL-AND-JAM/REGISTER BLOCKING)

```

1  for (int i = 0; i < m; i++) // Original code:
2      for (int j = 0; j < n; j++)
3          compute(a[i], b[j]); // Memory access is unit-stride in j

```

```

1  // Step 1: strip-mine outer loop
2  for (int ii = 0; ii < m; ii += TILE)
3      for (int i = ii; i < ii + TILE; i++)
4          for (int j = 0; j < n; j++)
5              compute(a[i], b[j]); // Same order of operation as original

```

```

1  // Step 2: permute and vectorize outer loop
2  for (int ii = 0; ii < m; ii += TILE)
3  #pragma simd
4      for (int j = 0; j < n; j++)
5          for (int i = ii; i < ii + TILE; i++)
6              compute(a[i], b[j]); // Use each vector in b[j] a total of TILE times

```

LOOP TILING (UNROLL-AND-JAM) -- ALTERNATIVE IMPLEMENTATION

```

1  for (int i = 0; i < m; i++)    // Original code:
2      for (int j = 0; j < n; j++)
3          compute(a[i], b[j]); // Memory access is unit-stride in j

```

```

1  // Step 1: strip-mine both loops
2  for (int ii = 0; ii < m; ii += TILE)
3      for (int i = ii; i < ii + TILE; i++)
4          for (int jj = 0; jj < n; jj += VECLLEN)
5              for (int j = jj; j < jj + VECLLEN; j++)
6                  compute(a[i], b[j]); // Same order of operation as original

```

```

1  // Step 2: permute middle two loops
2  for (int ii = 0; ii < m; ii += TILE)
3      for (int jj = 0; jj < n; jj += VECLLEN)
4          for (int i = ii; i < ii + TILE; i++)
5              for (int j = jj; j < jj + VECLLEN; j++)
6                  compute(a[i], b[j]); // Use each vector in b[j] a total of TILE times

```



CACHE-OBLIVIOUS RECURSION



EXAMPLE 1: MATRIX TRANSPOSITION, TILING

MATRIX TRANSPOSITION

Before:

```
1  #pragma omp parallel for
2  for (int i = 0; i < n; i++)
3      for (int j = 0; j < n; j++)
4          B[i*n + j] = A[j*n + i];
```

After:

```
1  const int tile = 200;
2  if (n%tile != 0) exit(1);
3
4  #pragma omp parallel for
5  for (int ii=0; ii<n; ii+=tile)
6      for (int jj=0; jj<n; jj+=tile)
7          for (int i=ii; i<ii+tile; i++)
8              for (int j=jj; j<jj+tile; j++)
9                  B[i*n + j] = A[j*n + i];
```



EXAMPLE 2: MATRIX-VECTOR MULTIPLICATION, TILING

EXAMPLE: MATRIX-VECTOR MULTIPLICATION

$$c_i = \sum_{j=0}^n A_{ij} b_j, \quad i = 0, 1, \dots, (m-1). \quad (1)$$

```

1 void Multiply(const double* const A, const double* const b,
2              double* const c, const long n, const long m){
3     assert(n%64 == 0);
4     #pragma omp parallel for
5     for (long i = 0; i < m; i++)
6     #pragma vector aligned
7         for (long j = 0; j < n; j++) // Each value of A[i*n+j] is used only once
8             c[i] += A[i*n+j] * b[j]; // Each value of b[j] is used a total of m times
9 }

```

Non-optimal performance due to inefficient cache use

APPLYING TILING

```

1  const long jTile = 4096L; assert(n%jTile == 0);
2  #pragma omp parallel
3  {
4      double temp_c[m] __attribute__((aligned(64)));
5      temp_c[:] =0;
6      #pragma omp for
7      for (long jj =0; jj < n; jj+=jTile) // Loop Tiling in j
8          for (long i = 0; i < m; i++)
9              #pragma vector aligned
10                 for (long j =jj; j < jj+jTile; j++)
11                     temp_c[i] += A[i*n+j] * b[j];
12
13     for(long i = 0; i < m; i++) { // Reduction
14         #pragma omp atomic
15         c[i]+= temp_c[i];
16     } } }

```

CACHE BLOCKING + STRIP-MINE AND COLLAPSE

```
1  const long iTile = 64L;    assert(m%iTile == 0);
2  const long jTile = 4096L; assert(n%jTile == 0);
3  #pragma omp parallel
4  {
5      double temp_c[m] __attribute__((aligned(64))); temp_c[:] =0;
6  #pragma omp for collapse(2)
7      for (long ii = 0; ii < m; ii += iTile)
8          for (long jj = 0; jj < n; jj += jTile)
9              for (long i = ii; i < ii+iTile; i++)
10 #pragma vector aligned
11                 for (long j =jj; j < jj+jTile; j++)
12                     temp_c[i] += A[i*n+j] * b[j];
13
14     for(long i = 0; i < m; i++) {
15 #pragma omp atomic
16         c[i]+= temp_c[i];
17 } } }
```



EXAMPLE 3: MATRIX-VECTOR MULTIPLICATION, RECURSION

EXAMPLE: MATRIX-VECTOR MULTIPLICATION

```

1 void RecursMultiply(const double* const A, const double* const b,
2     double* const c, const long n, const long m, const long lda){
3     const long jThreshold = 8192L; assert(n%jThreshold == 0);
4     const long iThreshold = 64L;  assert(m%iThreshold == 0);
5     if ((m<=iThreshold) && (n<=jThreshold)) { // Recursion threshold
6         // .... Base Case: Compute the result inside the tile ... //
7     } else { // Recursive divide-and-conquer
8         if (m*jThreshold > n*iThreshold) { // Split i-wise
9             double c1[m/2] __attribute__((aligned(64)));
10 #pragma omp task
11     { RecursMultiply(&A[0*lda + 0], &b[0], c1, n, m/2, lda); }
12     double c2[m/2] __attribute__((aligned(64)));
13     RecursMultiply(&A[(m/2)*lda + 0], &b[m/2], c2, n, m/2, lda);
14 #pragma omp taskwait
15     c[0:m/2] += c1[0:m/2]; c[m/2:m/2] += c2[0:m/2]; // Reduction
16     } else { // .... Split j-wise .... // }
17 } }

```

PERFORMANCE OF MATRIX VECTOR MULTIPLICATION

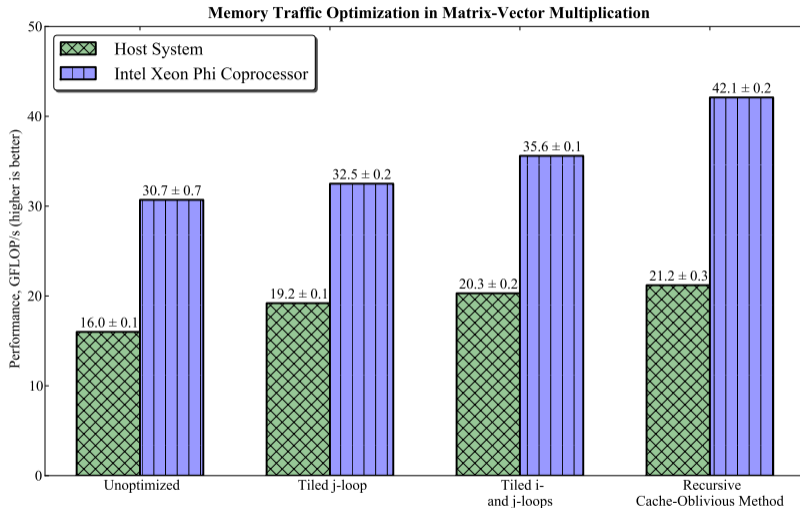



BANDWIDTH TUNING

STREAM BENCHMARK

- ▶ Industry-standard tool for memory bandwidth measurement
- ▶ 4 tests: COPY, ADD, SCALE and TRIAD
- ▶ Download from Dr. John McCalpin's site:
www.cs.virginia.edu/stream/

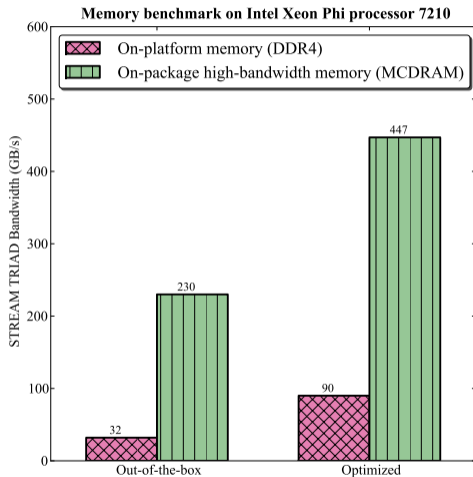

STREAM BENCHMARK TUNING

- ▶ KNL: Compile with `-xMIC-AVX512`
- ▶ Set large enough array size: `-DSTREAM_ARRAY_SIZE=64000000`
- ▶ Set 1 thread per core (-1 for offload)
- ▶ Xeon CPU: set affinity “scatter” (default on Xeon Phi)
- ▶ KNC: Tune prefetching ([learn more](#))

In addition, secret sauce for your own STREAM-like application:

- ▶ Parallel first touch (see Session 8 of the [HOW Series](#))
- ▶ Essential element – streaming stores: [discussion](#)

USING HIGH-BANDWIDTH MEMORY (MCDRAM) IN KNL

Option 1 : cache/hybrid mode

- ▶ Treat it as LLC
- ▶ Data locality techniques
- ▶ Miss latency 2x the direct DDR4 access

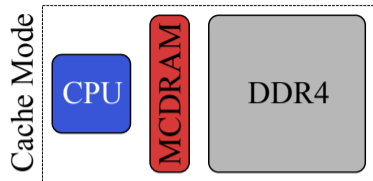

Option 2 : flat mode

- ▶ Application fits in 16 GiB? `numactl`
- ▶ More than 16 GiB data? Use special allocators (e.g., `memkind`)

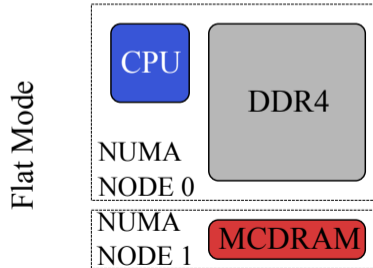

BINDING TO NUMA NODES WITH `numactl`

- ▶ `numactl` – a Linux tool for controlling NUMA policy for processes

```
vega@lyra% numactl --hardware
available: 2 nodes (0-1)
node 0 cpus: 0 1 2 3 4 5 12 13 14 15 16 17
node 0 size: 65457 MB
node 0 free: 24426 MB
node 1 cpus: 6 7 8 9 10 11 18 19 20 21 22 23
node 1 size: 65536 MB
node 1 free: 53725 MB
node distances:
node  0  1
  0:  10  21
  1:  21  10
vega@lyra% numactl --membind=<nodes> --cpunodebind=<nodes> ./myApplication
```

HBM IN KNIGHTS LANDING

- ▶ Finding HBM (MCDRAM) in an Intel Xeon Phi processor x200 (KNL):

```
user@knl% # In Flat mode with All-to-All or Quadrant
user@knl% numactl -H
available: 2 nodes (0-1)
node 0 cpus: 0 1 2 3 4 5 6 7 8 9 10 11 12 13 14 ... 249 250 251 252 253 254 255
node 0 size: 98207 MB
node 0 free: 94798 MB
node 1 cpus:
node 1 size: 16384 MB
node 1 free: 15991 MB
```

- ▶ Binding the application to HBM (Flat/Hybrid)

```
user@knl% numactl --membind 1 ./runme
// ... Application running in HBM ... //
```



§4. REVIEW AND WHAT'S NEXT

SUMMARY

This session:

1. Data re-use in caches: increase arithmetic intensity
 - 1.1 Loop permutation: achieve unit-stride access
 - 1.2 Loop fusion: re-use data as soon as possible
 - 1.3 Loop tiling: cache blocking and unroll-and-jam
 - 1.4 Cache-oblivious recursion: portable
2. Access to main memory:
 - 2.1 1 thread/core, “scatter” affinity
 - 2.2 “Secret sauce” compiler arguments for KNC
 - 2.3 First-touch allocation in NUMA systems
 - 2.4 High-bandwidth memory (HBM) in KNL: numactl or memkind

Next session: distributed computation with MPI, specifics of message passing with coprocessors.



LEARN MORE

HOW SERIES: KNIGHTS LANDING

HOW SERIES "KNIGHTS LANDING":

PROGRAMMING AND OPTIMIZATION FOR
INTEL XEON PHI X200 FAMILY

Free 2-hour video course



colfaxresearch.com/how-knl/

ISBN: 978-0-9885234-0-1 (508 pages, Electronic or Print)

Parallel Programming
and Optimization with
Intel® Xeon Phi™
Coproprocessors

Handbook on the Development and
Optimization of Parallel Applications
for Intel® Xeon® Processors
and Intel® Xeon Phi™ Coprocessors

© Colfax International, 2015

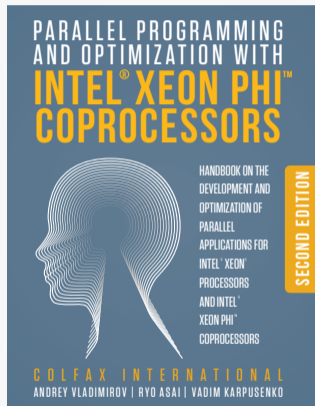

<http://xeonphi.com/book>

COLFAX RESEARCH
Log In/Out or Register

READ WATCH LEARN CONNECT JOIN

To search, type and hit enter

Popular

The Hands-On Tutorials (HOT) webinars: details on efficient programming for Intel architecture

The Hands-On Workshop (HOW) Series

Introduction to Intel DAAL, Part 1: Polynomial Regression with Batch Mode Computation

Parallel Programming Book

Introduction to parallel programming, deep discussion of optimization techniques, exercises.

Research and Educational Publications

Introduction to Intel DAAL, Part 1 of 3: Polynomial Regression with Batch Mode Computation

Optimization Techniques for the Intel MIC Architecture, Part 3 of 3: False Sharing and Padding

Software Developer's Introduction to the HGST Ultrastar Archive H700 SMR Drives

Optimization Techniques for the Intel MIC Architecture, Part 2 of 3: Strip-Mining for Vectorization

Optimization Techniques for the Intel MIC Architecture, Part 1 of 3: Multi-Threading and Parallel Reduction

Performance to Power and Performance to Cost Ratios with Intel Xeon Phi Coprocessors (and why ix Acceleration May Be Enough)

Featured Video

See Research material on vectorization in a streaming mode



▶

Consulting



Colfax offers consulting services for enterprises, research help you to:

- Optimize your existing application to take advantage of parallelism, from vectors to cores to clusters and
- Future-proof your application for upcoming innovations
- Accelerate your application using coprocessor tech
- Investigate the potential system configurations that satisfy your cost, power, performance requirements.
- Take a clean slate to develop a novel approach to solve your computing problem

Episode 2.1 — Purpose of the MIC architecture



Software Developer's Introduction to the HGST Ultrastar Archive H700 SMR Drives



Colfax offers consulting services for enterprises, research help you to:

- Optimize your existing application to take advantage of parallelism, from vectors to cores to clusters and
- Future-proof your application for upcoming innovations
- Accelerate your application using coprocessor tech
- Investigate the potential system configurations that satisfy your cost, power, performance requirements.
- Take a clean slate to develop a novel approach to solve your computing problem

Fluid Dynamics with Fortran on Intel Xeon Phi coprocessors



Configuration and Benchmarks of Peer-to-Peer Communication over Gigabit Ethernet and InfiniBand in a Cluster with Intel Xeon Phi Coprocessors



Interview with James Reinders: future of Intel MIC architecture, parallel programming, education



http://colfaxresearch.com/

colfaxresearch.com/how-16-09

LEARN MORE

© Colfax International, 2013–2016